

Hogar

Design by Stéphane Joyeux





IP65 (LED)
IP44 (GU10)
IK10
Class 1

Aluminium
Satin-finish PMMA diffuser

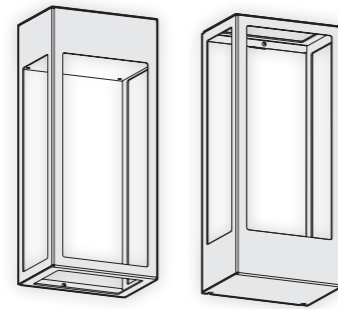

Down light convertible into up light

Dimmable 1-10 Volt or Dali

H 600 mm
W 260 mm
D 183 mm

SOURCES

GU10 2x9W
LED 26W - 3000K warm white
LED 26W - 4000K neutral white
LED 35W - 1-10 Volt dimmable - 3000K warm white
LED 35W - 1-10 Volt dimmable - 4000K neutral white
LED 35W - DALI dimmable - 3000K warm white
LED 35W - DALI dimmable - 4000K neutral white

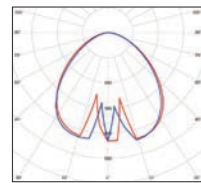

Models 1 to 3

LED 26W - IP65
Real light output - 1952 lm
IRC > 80

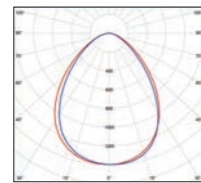

Model 4

LED 26W - IP65
Real light output - 2055 lm
IRC > 80

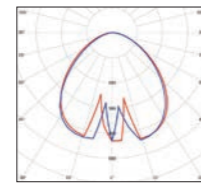

Models 1 to 3

LED 35W - IP65
Real light output - 2628 lm
IRC > 80

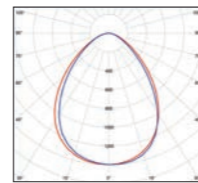

Model 4

LED 35W - IP65
Real light output - 2767 lm
IRC > 80

MODELS

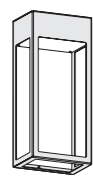

H600 . W260 . D 183
1

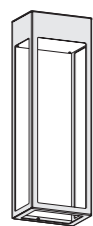

H800 . W260 . D 183
2

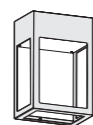

H400 . W260 . D 183
3



H 105 . W260 . D 183
4



REFERENCES

Replace ●●● with the colour code

MODELS	GU10 2x9W	LED 26W 3000K warm white	LED 26W 4000K neutral white	LED 35W 3000K warm white 1-10 Volt dimmable	LED 35W 4000K neutral white 1-10 Volt dimmable	LED 35W 3000K warm white Dali dimmable	LED 35W 4000K neutral white Dali dimmable	SPARE DIFFUSER
1	177 058 ●●●	177 010 ●●●	177 012 ●●●	177 026 ●●●	177 028 ●●●	177 042 ●●●	177 044 ●●●	165 090 616
2	177 060 ●●●	177 014 ●●●	177 016 ●●●	177 030 ●●●	177 032 ●●●	177 046 ●●●	177 048 ●●●	165 090 616
3	177 062 ●●●	177 018 ●●●	177 020 ●●●	177 034 ●●●	177 036 ●●●	177 050 ●●●	177 052 ●●●	165 090 616
4	177 064 ●●●	177 022 ●●●	177 024 ●●●	177 038 ●●●	177 040 ●●●	177 054 ●●●	177 056 ●●●	165 090 616

COLOURS CODES

Replace ●●● with the colour code

	RAL 9005 JET BLACK	000
	RAL 7021 BLACK GREY	107
	RAL 7044 SILK GREY	105
	RAL 9010 PURE WHITE	101
	RAL 5011 STEEL BLUE	065
	RAL 6025 FERN GREEN	109
	RAL 3013 TOMATO RED	110
	OLD RUSTIC	046

Other colours on request

MOUNTING

Wiring entry points in grey - Fixing kit included

